



# INSTALLATION MANUAL OF THE ELECTROSTATIC AIR CLEANERS + ACTIVATED CARBON V BANK FILTERS



# TABLE OF CONTENTS

**Front Page** - Installation manual of the electrostatic air cleaners + activated carbon v bank filtration

**Page 1:** Table of contents

**Page 2:** Quick Overview

**Page 3, 4:** STEP 1 - Removing components from the electrostatic air cleaner and activated carbon filtration units

**Page 5,6,7,8,8,9,10,11 :** STEP 2 - Hanging the electrostatic air cleaner

**Page 12,13 :** STEP 3 - Fixing the electrostatic air cleaner and activated carbon filtration together

**Page 14:** STEP 4 - Installing the ductwork inlet and outlet transitions on the electrostatic air cleaner

**Page 15:** STEP 5 - Preparing to put all the components back into the electrostatic air cleaner and activated carbon v bank filtration units.

**Page 16:** STEP 6 - Powering up the electrostatic air cleaner

# QUICK OVERVIEW

Electrostatic air cleaners and activated carbon filtration units from Ryd Air, also can be installed in a number of ways, including hanging from a frame, mounting on a wall, or sitting on a platform. Make sure you follow local regulations and authorities, and examine all wall or roof structures for any weight loads before installation

The RY – B series electrostatic air cleaners and CB series activated carbon v bank filters may be installed inside or outdoors, and they are modular in design for greater airflow rates. For example, units can be stacked on top of each other and are pre-bolted in the factory before arriving at the installation site.

Before making an order, AOS should be advised of the airflow direction, which should be either (right to left) or (left to right). The airflow will be modified at the AOS factory before it arrives on site for installation.

Before installing the electrostatic air cleaner and activated carbon v bank filters all pre filters and electrostatic cells and carbon panels should be removed to reduce the amount of weight when installing the unit, which will make handling the unit easier. If optional UV ozone is installed inside the esp unit, UV ozone lamps should be removed in case of damage or breakage.

The inlet and outlet transitions for the electrostatic air cleaner and activated carbon filtration unit should be carefully sealed to prevent any air or oil leaks when they are installed. The total airflow volume must be spread equally throughout the surface of the inlet and outlet sections in order to retain maximum efficiency. Short or sharp transitions should not be placed as they will damage the operation of the electrostatic air cleaner.

**Note: Before installing the electrostatic air cleaners and activated carbon filtration make sure there is adequate space and access for service and maintenance at least allow 800 mm for door openings on each electrostatic and carbon unit, The installer must coordinate adequate access.**

# STEP 1

## Removing all the components from inside the electrostatic air cleaner and activated carbon v bank filtration before installation

Open the access door at the face of the electrostatic unit via 2 black knobs to slide pre - filters and electrostatic cells from the rails inside the electrostatic unit use attached on the front of the cell to move electrostatic cells this will reduce the weight load. To remove UV ozone lamps use screwdriver to unscrew lamp holder and pull uv lamps out from the holder via sockets this will reduce breakage of the uv lamps.

Open the carbon access panel via 4 gold screws, open the door is open remove carbon panels accordingly to lessen the weight when installing.



2 Black Knobs



Electrostatic cell



Pre - filter

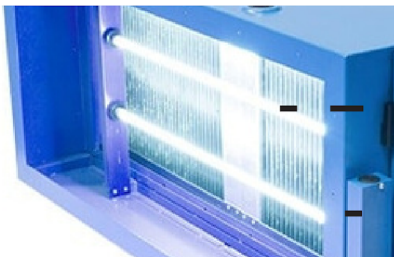

Remove UV ozone lamps

# STEP 1

**Removing all the components from inside the electrostatic air cleaner and activated carbon v bank filtration before installation**



Unscrew the door panel via x 4 screws on the activated carbon filtration unit



Slide carbon panels out of V formation

# STEP 2

## Hanging & securing the electrostatic air cleaner and activated carbon unit

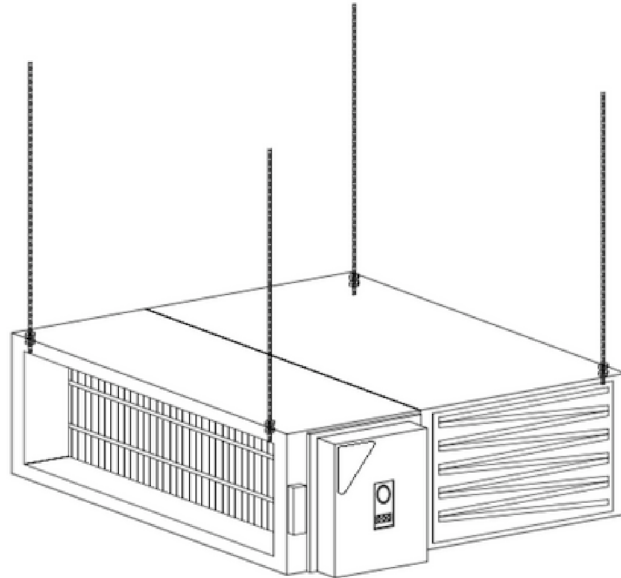

- Use a 10 mm or 12 mm threaded rod and a sleeve anchor to fix into concrete.
- On the top of the electrostatic unit, drill a 10.5 mm or 12.5 mm hole to slip the threaded rod through the top of the unit. Use nuts and bolts to fasten the threaded rod to the unit. Make sure electrostatic air cleaners are level and use genie hoist or lift to raise the electrostatic air cleaner and activated carbon unit in position.
- Place threaded rods on the corners of the unit rather than in the centre, if you install threaded rods in the centre pre filters and cells will not come out.
- if electrostatic air cleaners and activated carbon units are stacked they are pre - bolted in AOS Factory before arriving to site.
- Only stacked section or x 1 electrostatic air cleaner or x 1 activated carbon unit should be installed at once, do not attempt to install the entire electrostatic air cleaners and activated carbon filtration unit at once it becomes too heavy and awkward to install.
- If fixing electrostatic air cleaner and activated carbon unit to the wall check or wall structures before installing.
- **Note: Before hanging the esp unit and carbon unit make sure to inspect every structure for weight loads.**

# STEP 2

## Hanging & securing the electrostatic air cleaner and activated carbon v bank filtration

Stacked electrostatic air cleaner and activated carbon v bank filtration

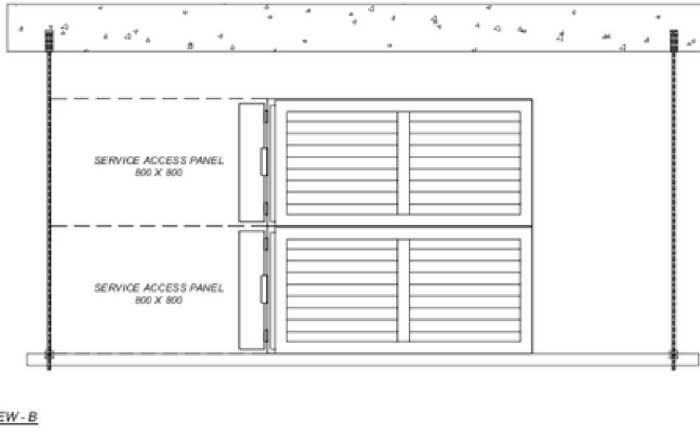
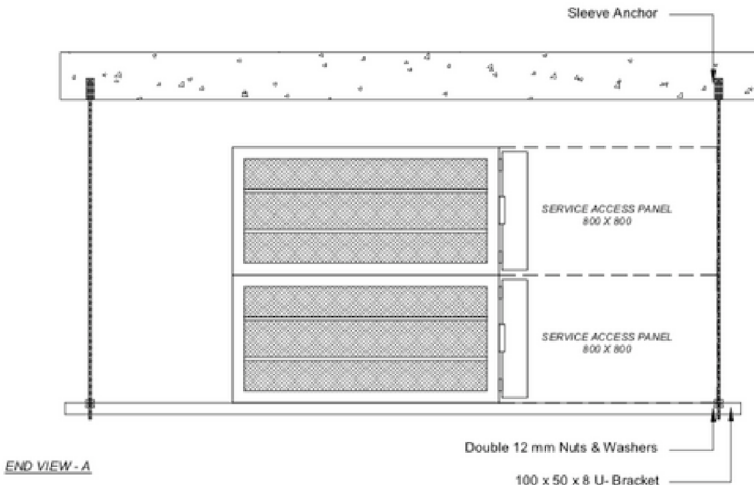
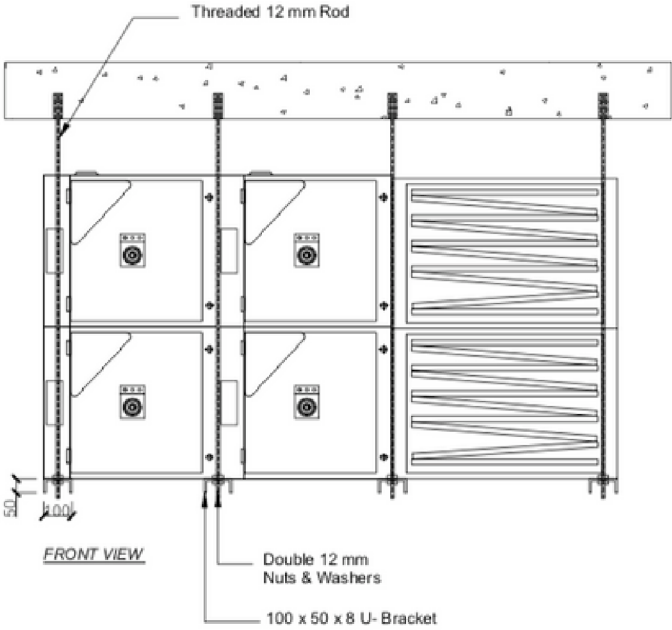
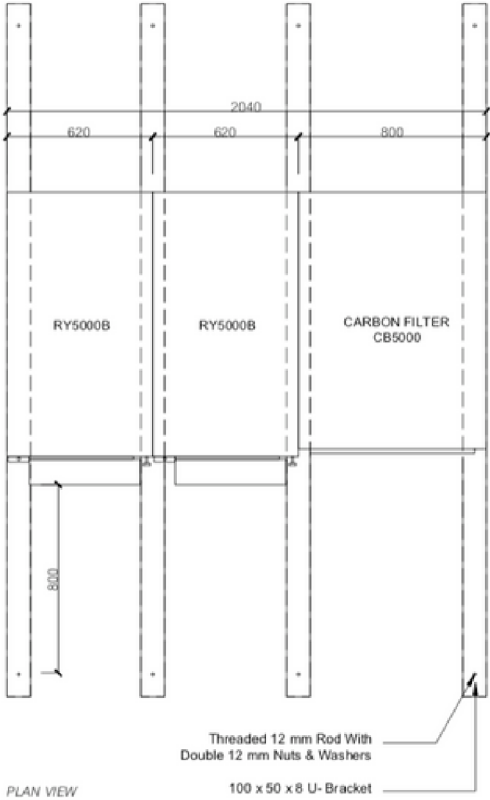

# STEP 2

## Hanging & securing the electrostatic air cleaner and activated carbon v bank filtration

Stacked electrostatic air cleaner and activated carbon v bank filtration

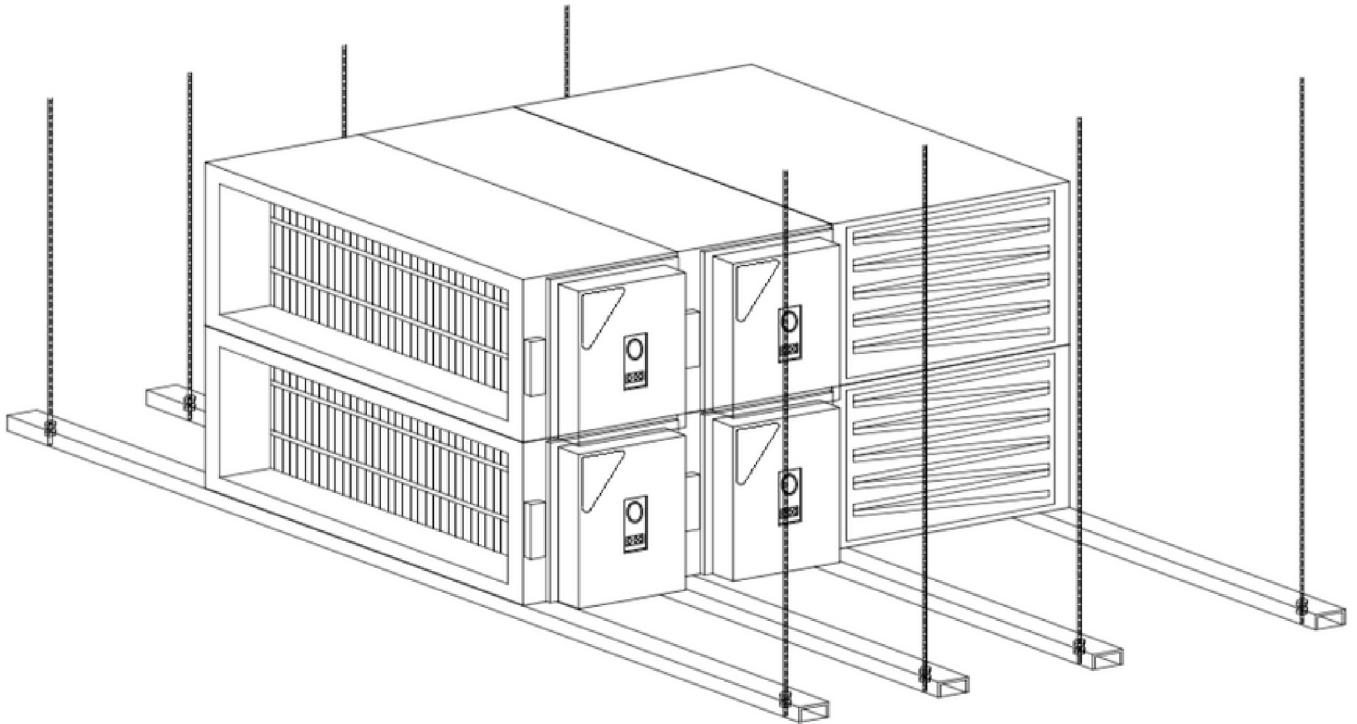

3D VIEW



# STEP 2

## Hanging & securing the electrostatic air cleaner and activated carbon v bank filtration

Double pass electrostatic air cleaner and activated carbon v bank filtration

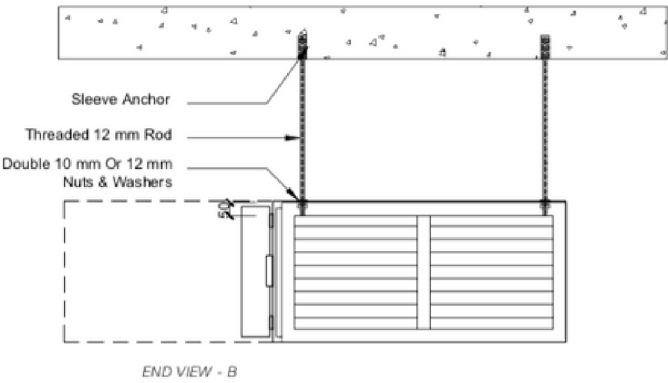
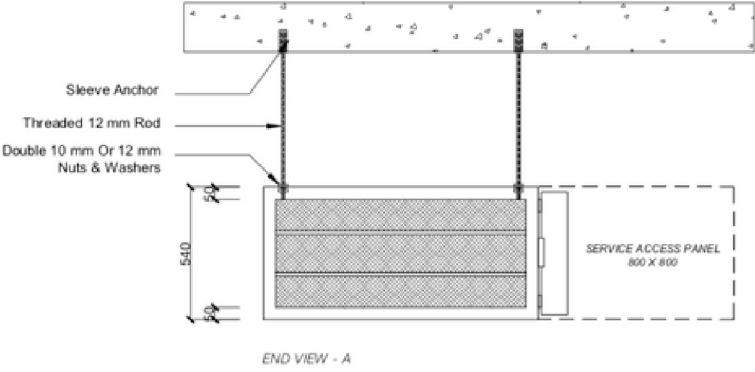
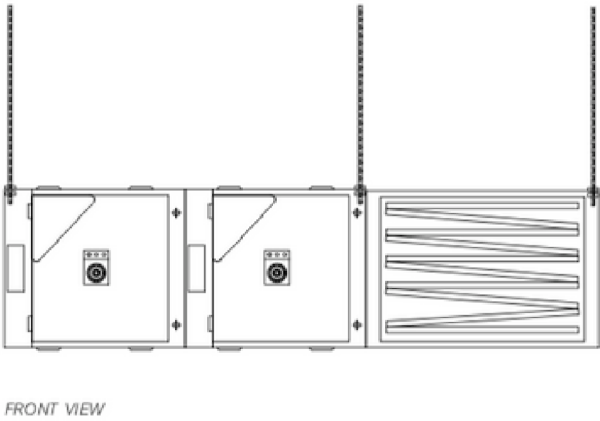
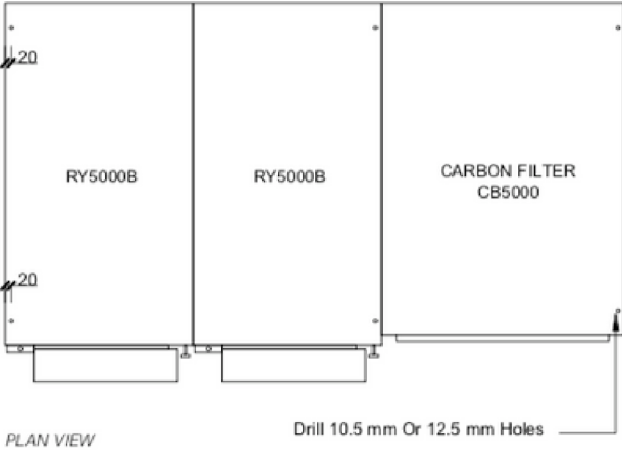

# STEP 2

## Hanging & securing the electrostatic air cleaner and activated carbon v bank filtration

Double pass electrostatic air cleaner and activated carbon v bank filtration

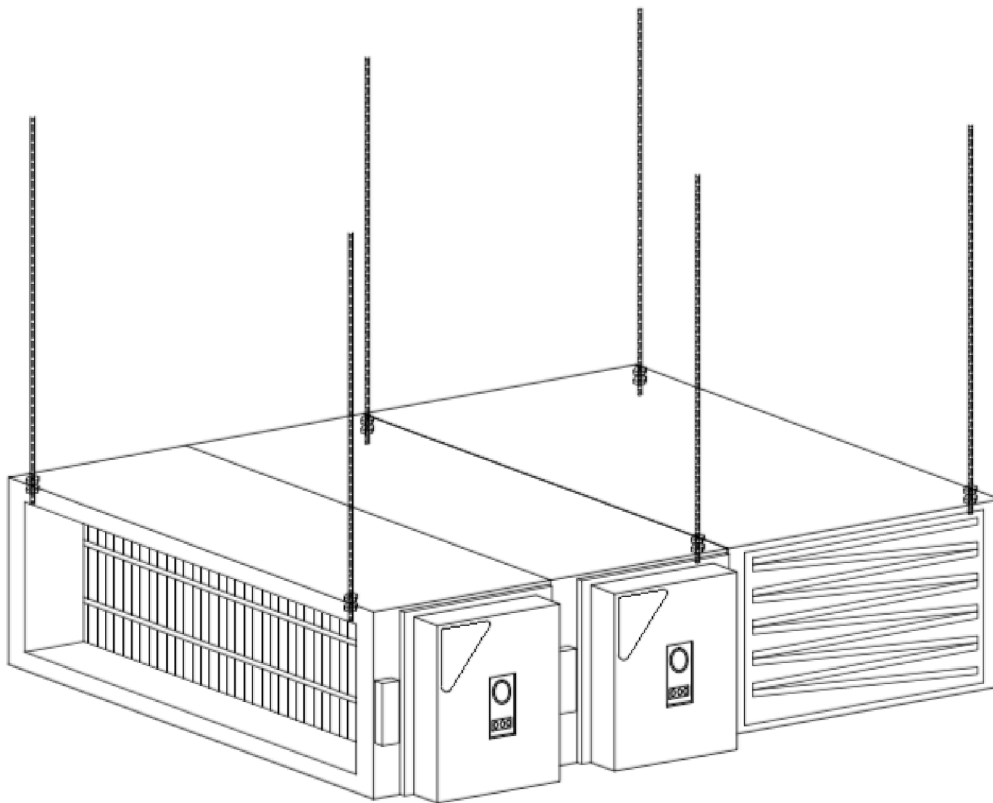

# STEP 2

## Hanging & securing the electrostatic air cleaner and activated carbon v bank filtration

Single pass electrostatic air cleaner and activated carbon v bank filtration

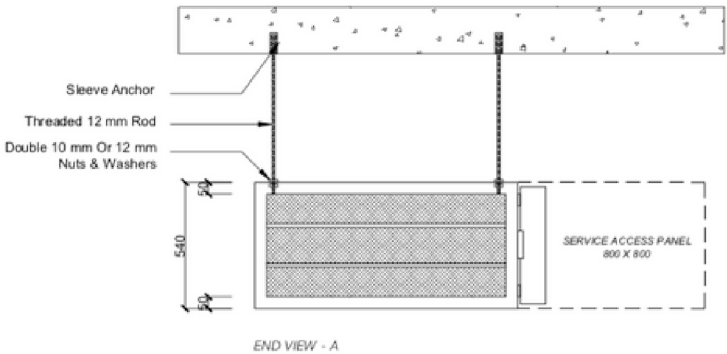
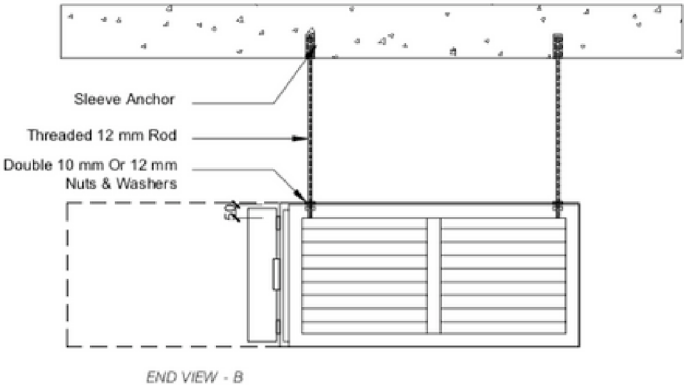
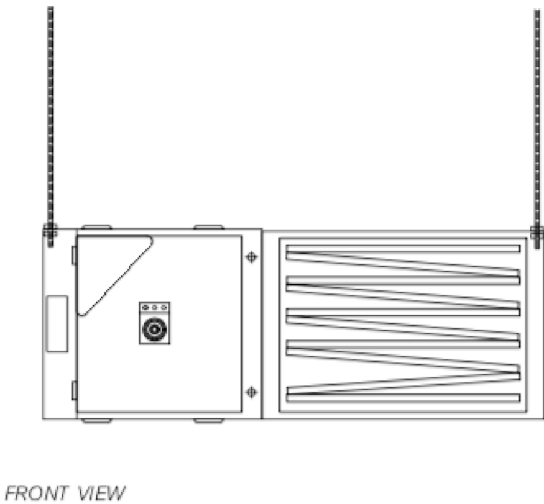
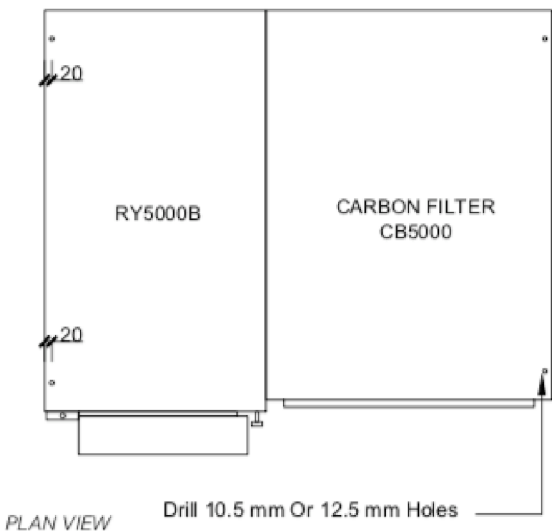

# STEP 2

## Hanging & securing the electrostatic air cleaner and activated carbon v bank filtration

Single pass electrostatic air cleaner and activated carbon v bank filtration

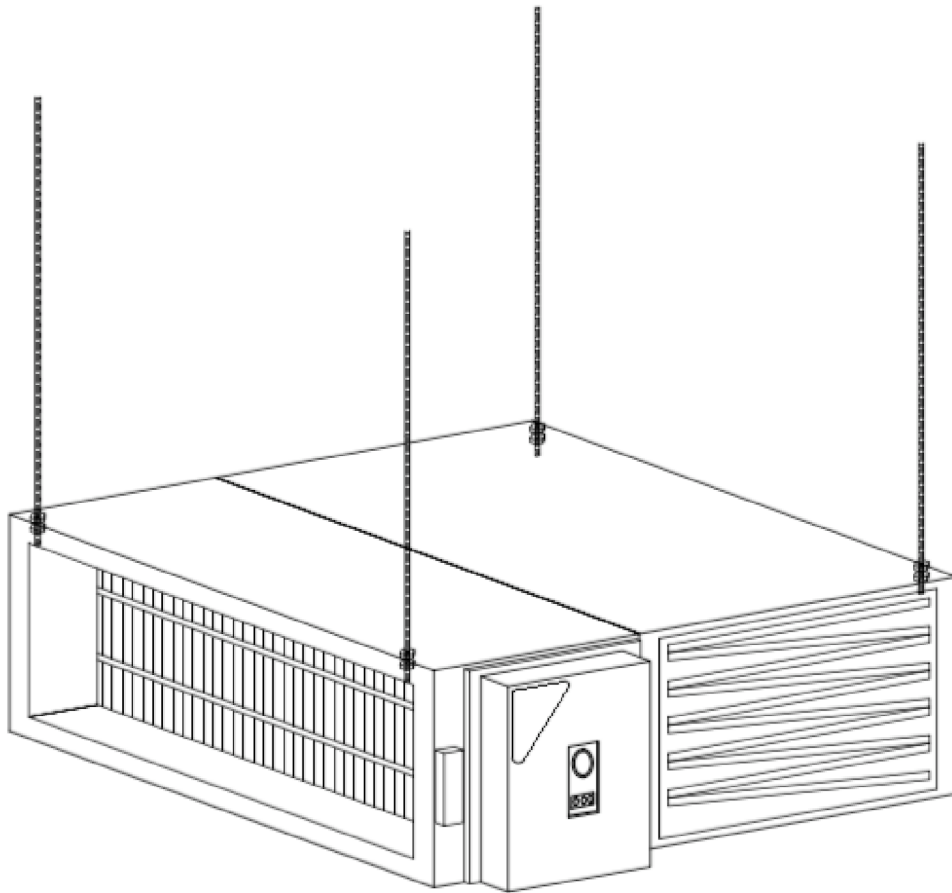

# STEP 3

## Fixing the electrostatic air cleaner and activated carbon v bank filtration together

There is a series of 2mm holes located around the inlet and outlet flange of the electrostatic unit and activated carbon filtration unit

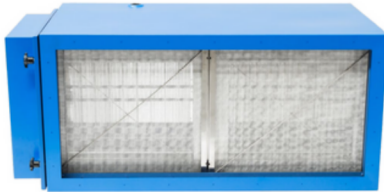

**2 mm series small holes located around the perimeter of the inlet and outlet flanges**

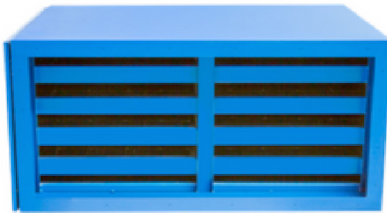

**Apply high temperature grease an oil resistant duct sealant to the flanges first before tex screwing the electrostatic air cleaner units together.**

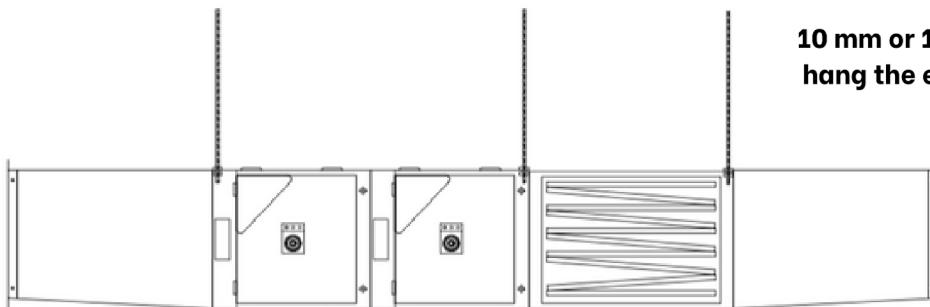

**10 mm or 12 mm threaded rod can be used to hang the electrostatic units to the concrete slab.**

**Electrostatic air cleaners are pre bolted together in AOS factory and esp units and tex screwed and sealed together when esp units are installed in modular or in series.**

# STEP 4

**Installing the ductwork inlet and outlet transitions on the electrostatic air cleaner and activated carbon v bank filtration.**

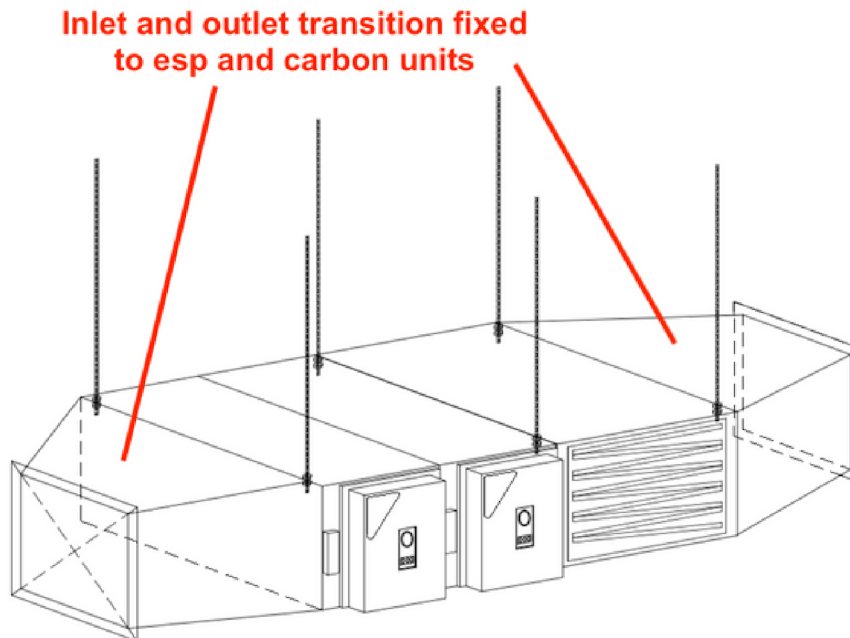

- The inlet and outlet transitions for the electrostatic air cleaner and activated carbon filters should be carefully sealed to prevent any air or oil leaks when they are installed. The total airflow volume must be spread equally throughout the surface of the inlet and outlet sections in order to retain maximum efficiency.
- Short or sharp transitions should not be placed as they will damage the operation of the electrostatic air cleaner.
- For maximum efficiency it is best to turn the ductwork in 50 mm when fixing to the flanges of the electrostatic unit.
- High temperature grease and oil sealant should be used to seal any air leaks or gaps and prevent any oil leaks.

# STEP 5

## Preparing to put all components back into the electrostatic air cleaner and activated carbon units

- When installation is completed ensure that all debris and dust is clear before if build up of dust you may need to wipe the inside of the electrostatic unit. If power is connected it is best to run the exhaust fan to clear any dust build up inside the electrostatic unit and activated carbon filtration unit.
- Check that the cell's compression pins line up with the high and low white door connectors on the inside of the door. All cell pin connectors on the front of the cell must face the same direction as the white circle door connectors.



**2 Pin connectors on the front of the cell**

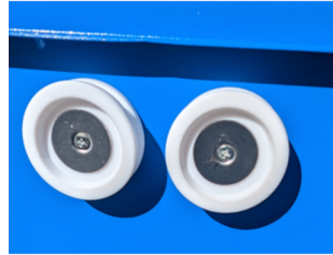

**2 white low / high insulator connectors**

- Pre-filters, electrostatic cells that must be slid back into the unit, and UV ozone lamps, if ordered, are among the parts that must be reinserted into the electrostatic air cleaner.



**Pre - filters**



**Electrostatic cells**



**UV ozone lamps to be re installed back in position back into lamp holder and brackets**

- Black drain plugs supplied with the electrostatic air cleaner unit must be installed at the top and bottom of the electrostatic air cleaner unit or oil and grease drainage.



**Top drain plug**



**Bottom drain plug**

# STEP 5

## Preparing to put all components back into the electrostatic air cleaner and activated carbon units

- Unscrew the door panel via x 4 screws on the activated carbon filtration unit



- Put the carbon panels in position in V formation use gloves and clean any debris inside the carbon unit. For longer carbon unit models load half the carbon panels in first and then push the remaining forward to the longest section ( load and push method)



- Secure x 4 screws on the access panel to the face of the carbon unit. The carbon filtration v bank unit is now operational.



# STEP 6

## Powering up the electrostatic air cleaner unit and activated carbon filtration units.

- When all pre -filters and electrostatic air cleaner cells are in the correct position in the electrostatic air cleaner and Uv ozone lamps are installed correctly, the electrostatic air cleaner unit will be ready to be powered up. The carbon panels must be correctly positioned in V formation
- All electrostatic air cleaner power connection is provided at the electrical junction box with 1 metre long 240 Volts ( 3 Pin - male plug) ready for connection factory tested and commissioned.

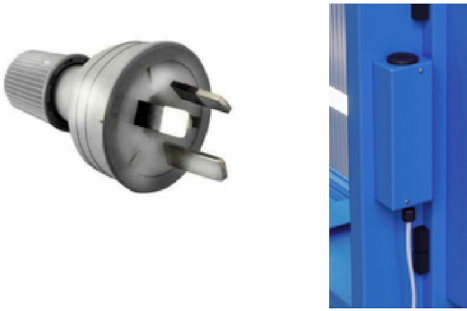

- Note: Electrostatic air cleaner with / without uv ozone should be electrically interlocked with the kitchen exhaust fan.
- Once power is turned on you may hear crackling or arcing sound this is normal as dust is being sucked into the cells which is now energized at 12 - 14kv or 6 - 7Kv.
- The indicator lights will illuminate and indicate the following below on the LED indicators at the face of the electrostatic air cleaner.
- GREEN light is ON ● electrostatic air cleaner unit is functioning correctly.
- Flickering RED ● to GREEN ● electrostatic air cleaner is crackling and arcing this is normal dust is being sucked up into the cells.
- Both RED ● & GREEN ● lights are ON faulty cell or maintenance required.
- RED light is ON ● faulty power pack prolonged usage without maintenance.
- Blue lights are illuminated UV ozone lamps are ON ●
- No Blue lights illuminated UV Ozone lamps are OFF

**Note: No power required for the carbon filtration unit.**

**If you have any problems, please call AOS at (02) 9721 0020 or email [info@aosaus.com.au](mailto:info@aosaus.com.au).**